

ATSR: Design and Engineering of a Precision Radiometer

Optics, Cooler, Structure,

For a radiometry we need to know:

- Field of view
- Spectral Response
- Radiometric Calibration



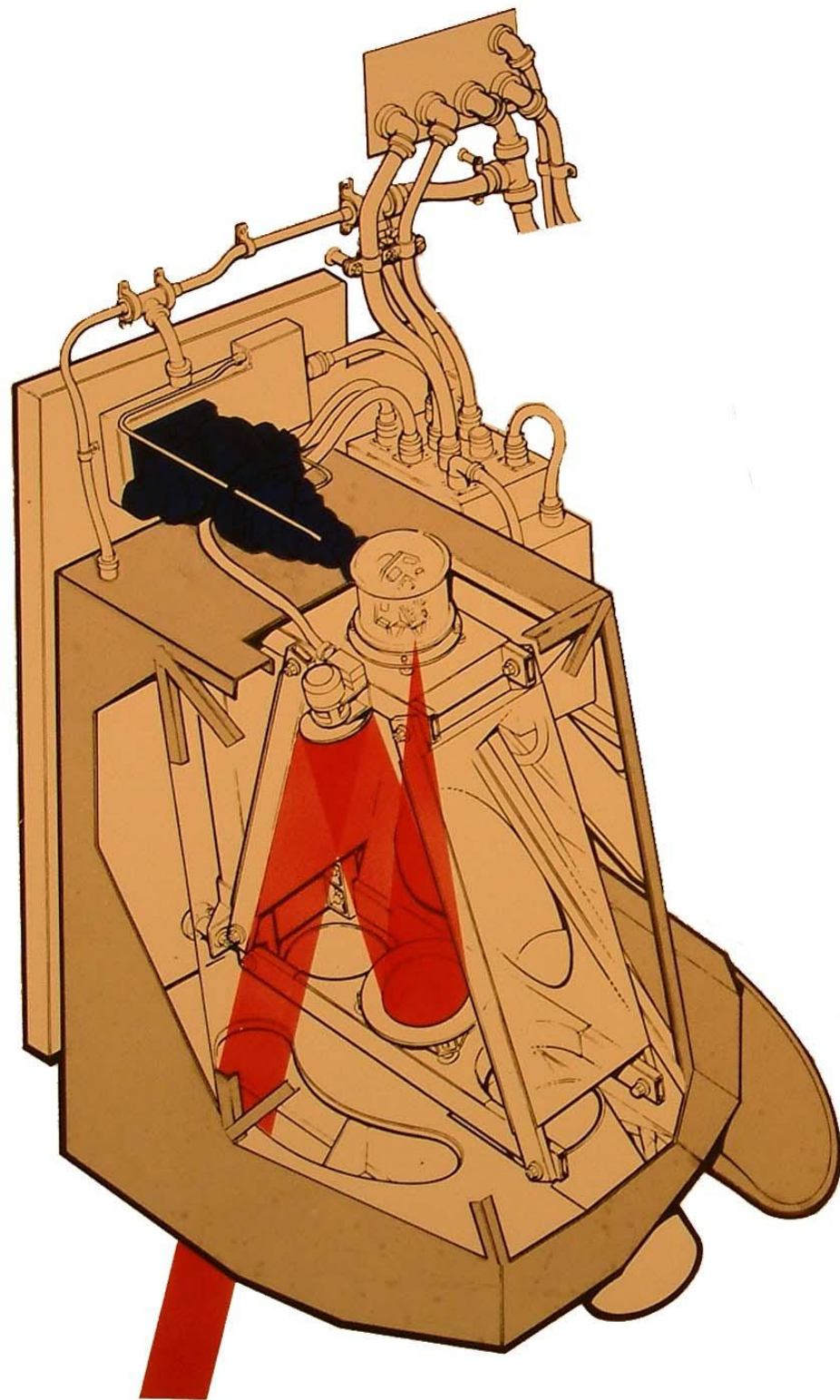

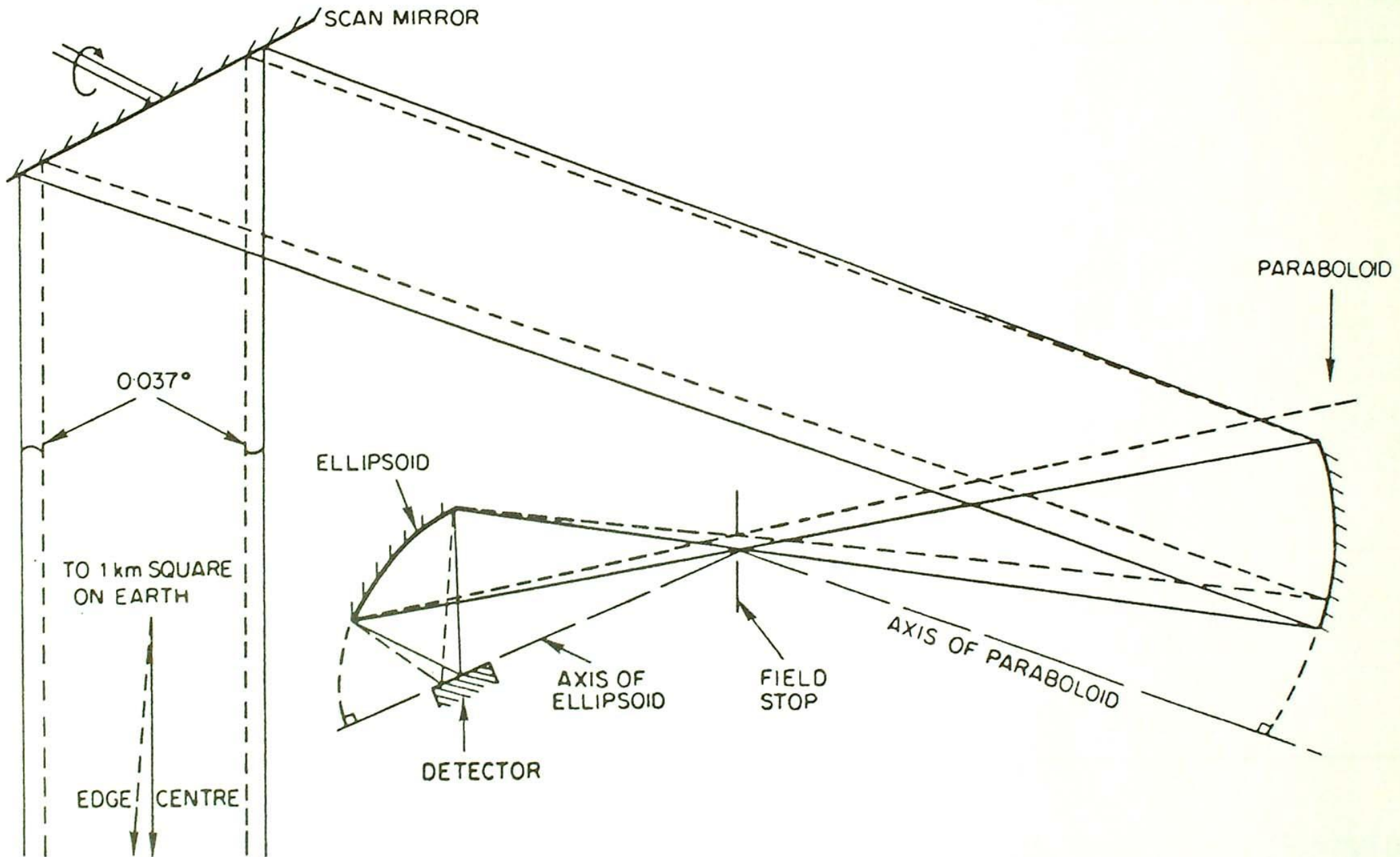

ELECTRICAL INTERFACE

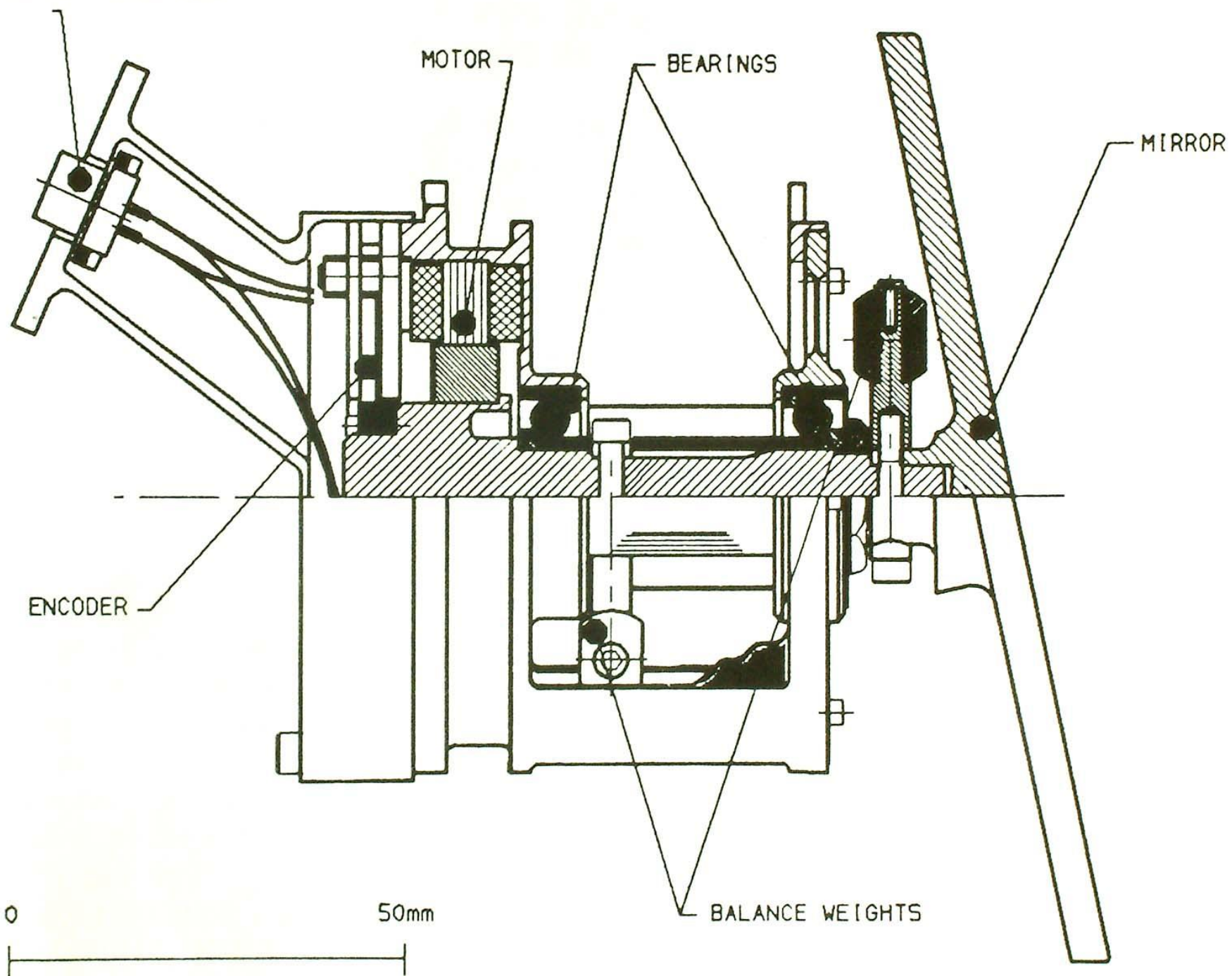

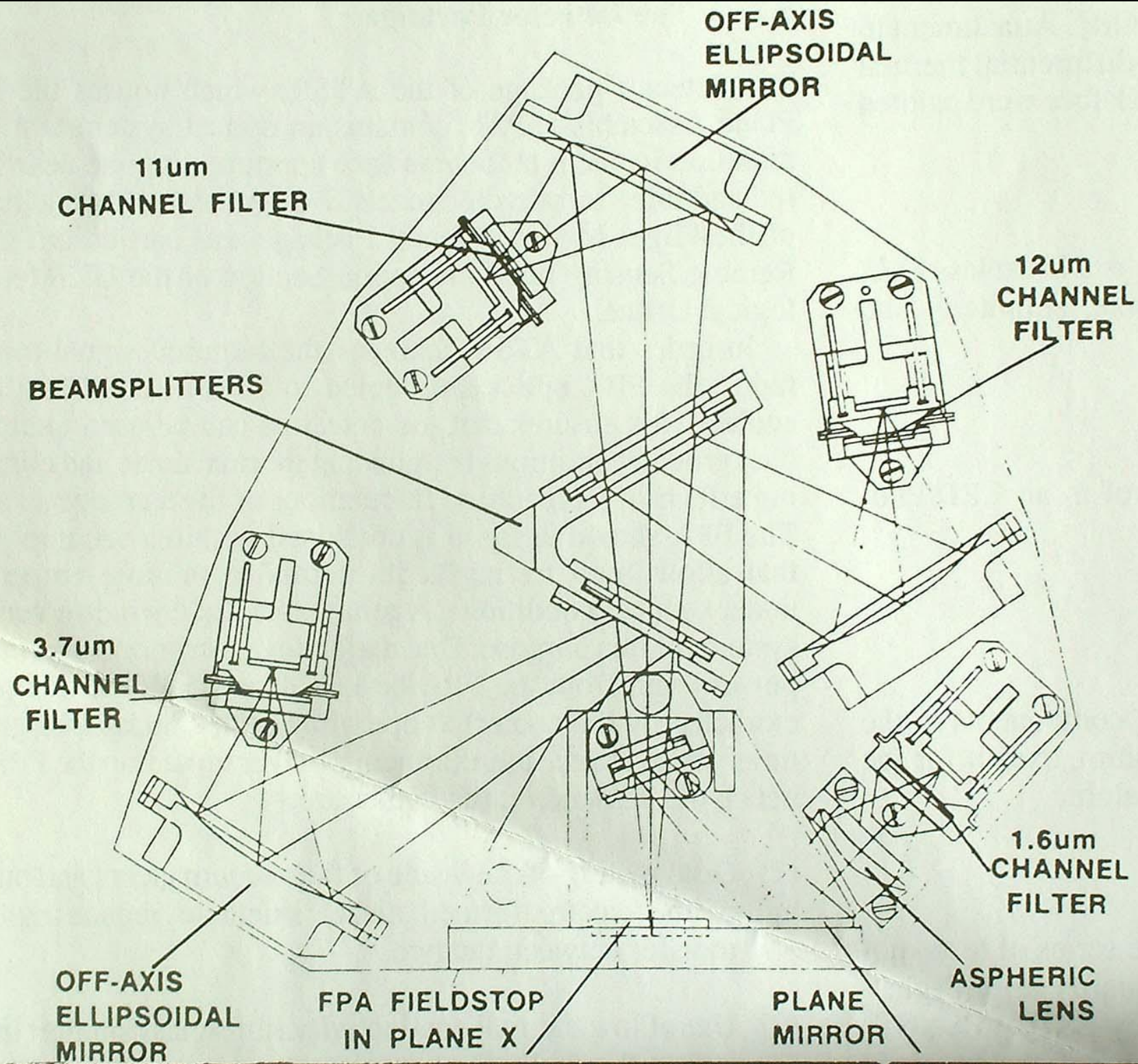

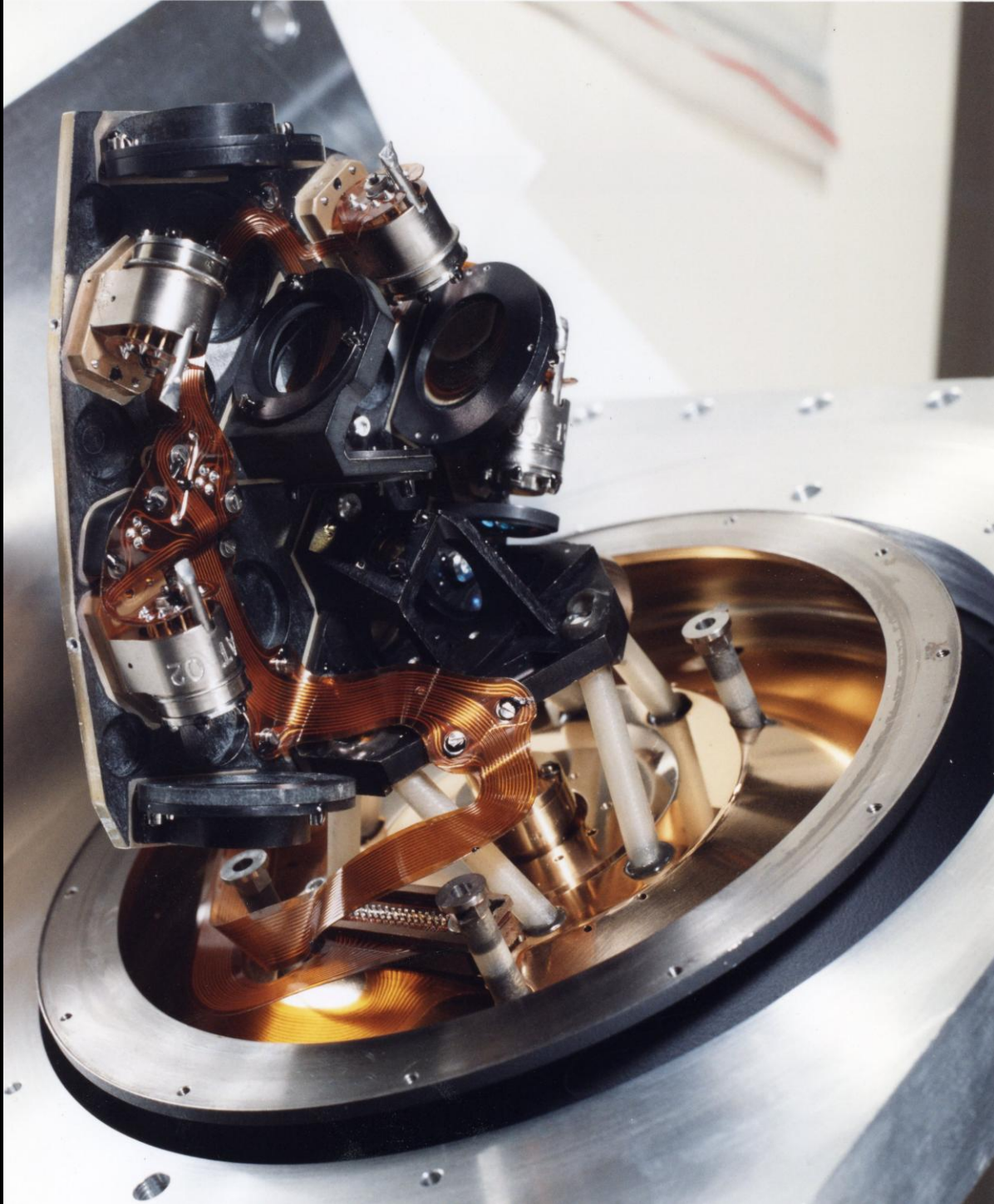

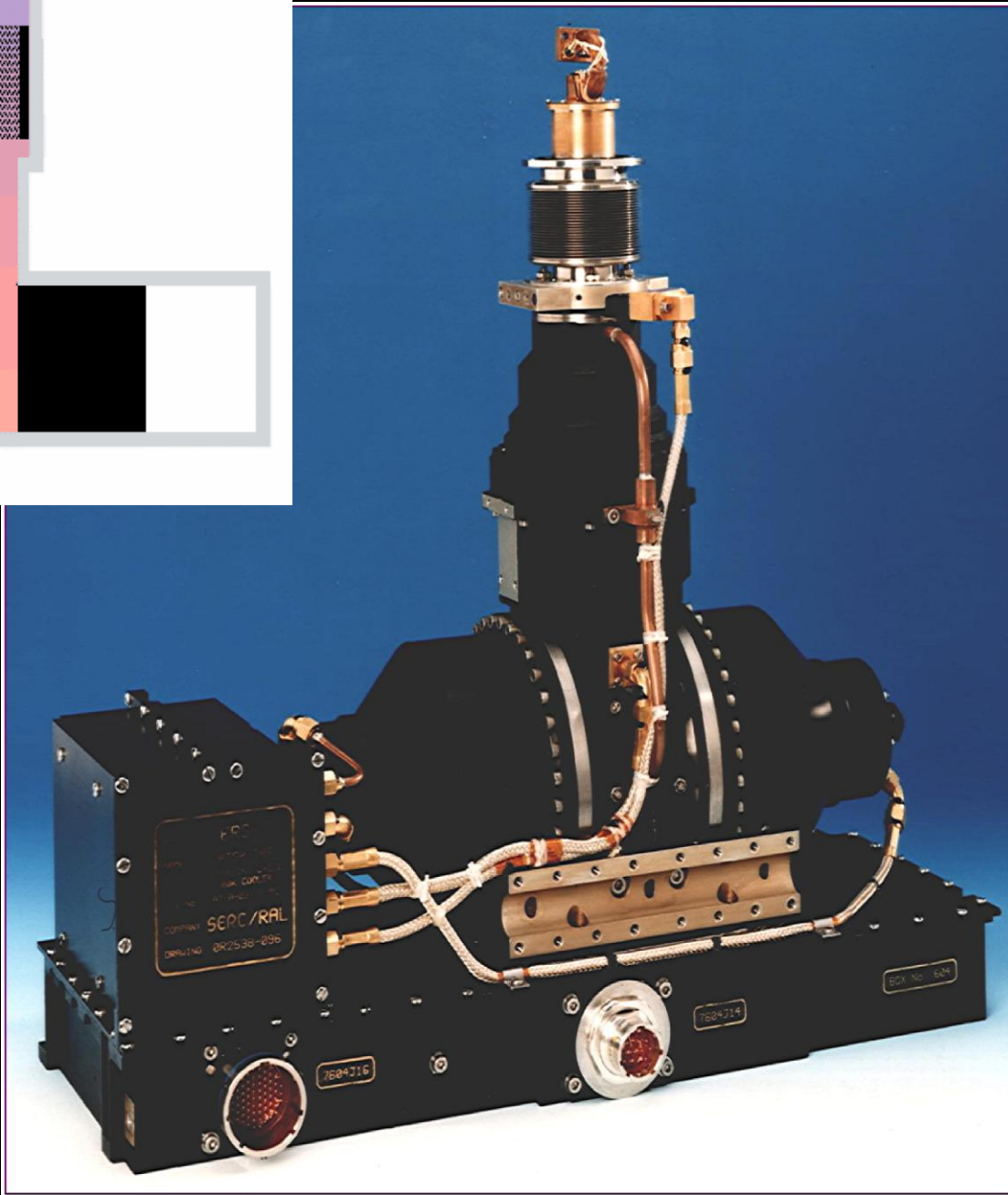
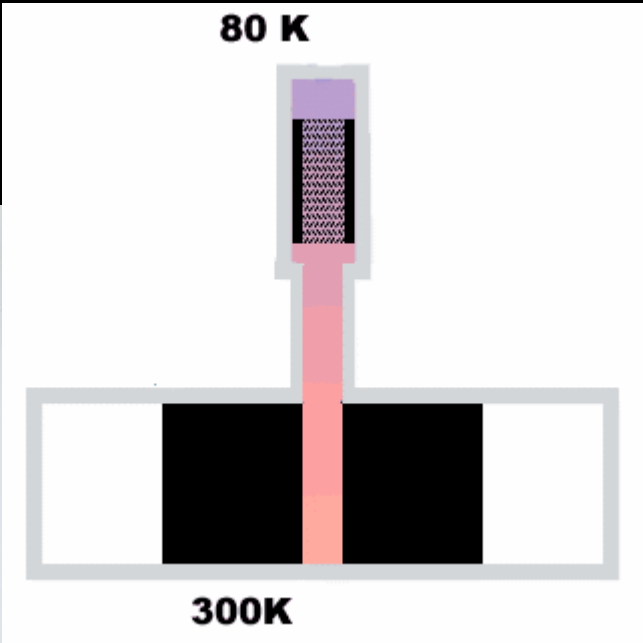

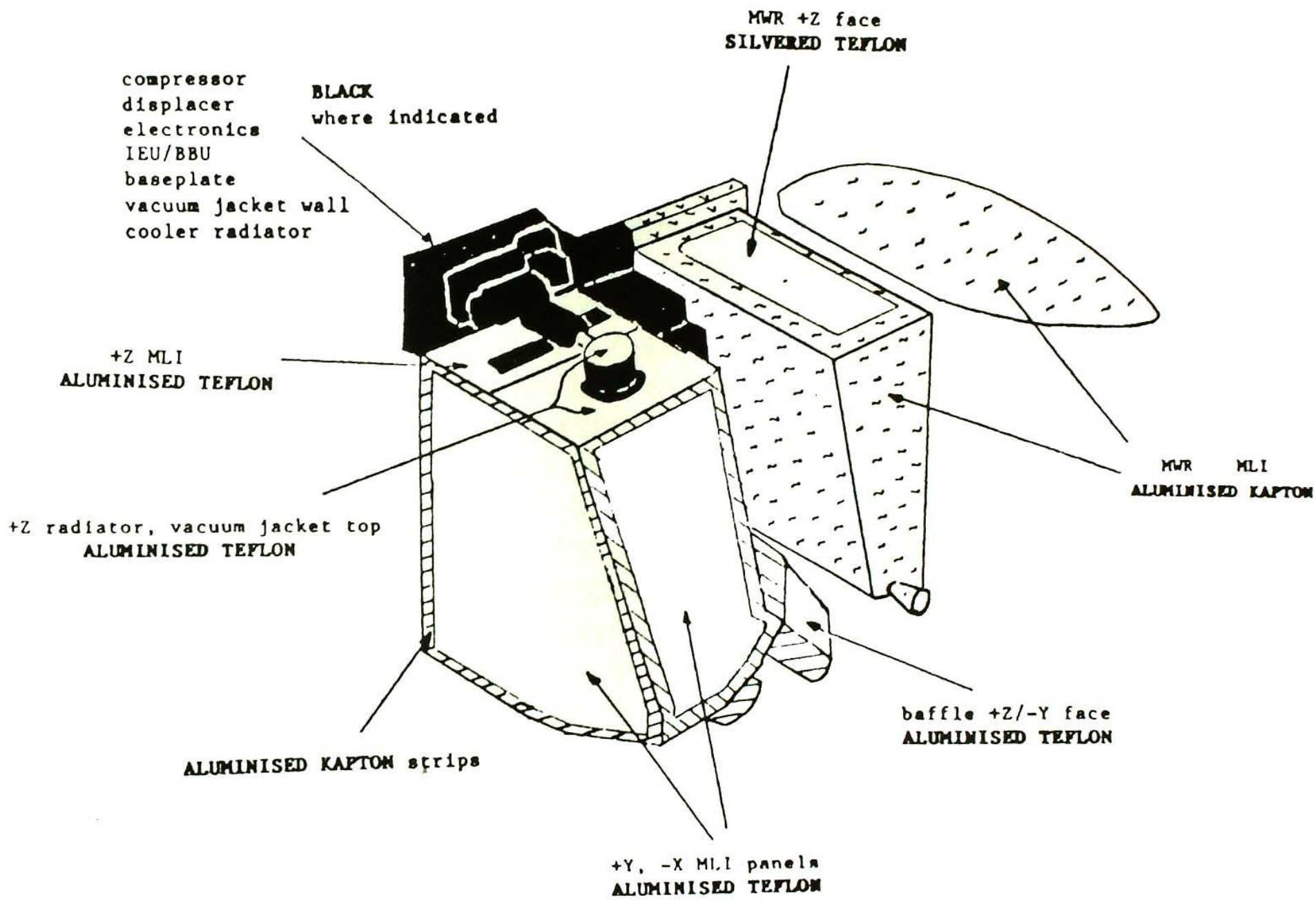







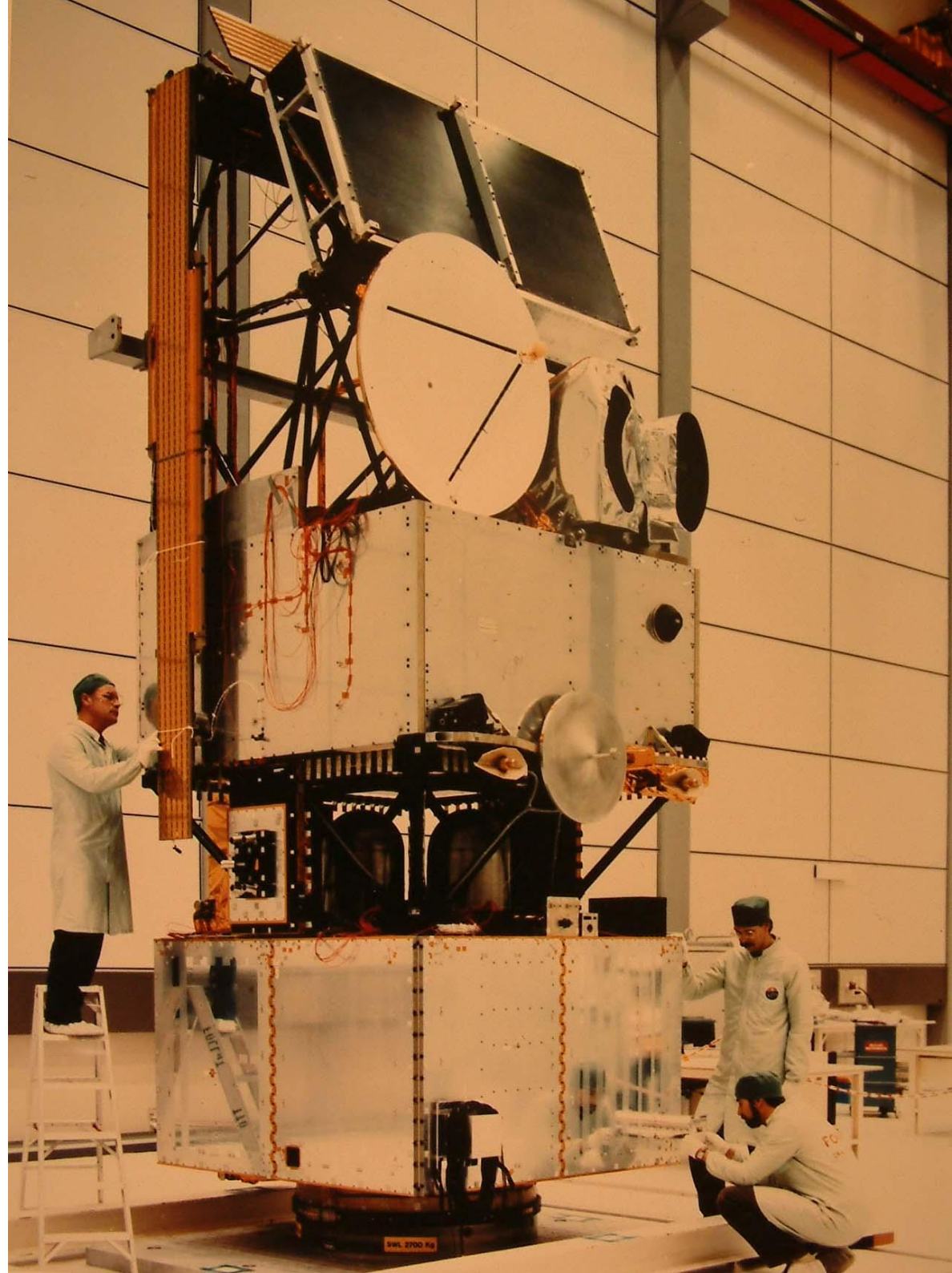





ENVISAT



Key Design and Engineering Features:

Optics, Cooler, Structure/thermal...

Thanks for talk material to:

- ATSR Critical Design Review (May 1987)
- T. Edwards et al, JBIS (1990, p160)
- D. Llewellyn-Jones - D. Simpson - J. Delderfield

